

Thermostat controls 24V millivolt furnaces and air conditioners.
NOTE: This thermostat is NOT compatible with baseboards or
any 120V or 240V high voltage control system.



Programmable Thermostat THM303A

TABLE OF CONTENTS

Features	4
Compatibility chart	6
INSTALLATION GUIDE	7
Introduction	8
Installing the battery and selection of °C/ °F display	8
Tools for installation	9
Choosing location for the new thermostat.	10
Replacing old thermostat.	11
Mounting the thermostat back-cover	12
Connecting the wires to the terminals	13
Wiring Diagram.	14
Installing control wires for humidifier control.	15
Setting the fan operation jumper	16
Attaching the thermostat to the back-cover.	17-18
Function Key descriptions	19
LCD Display / Set time and day	20
PROGRAMMING	21
Heating program	22-23
Cooling program	24

TABLE OF CONTENTS

Temporary override	23
Hold function	23
Check programs	24
Room temperature	24
Relative humidity	24
Humidifier control	24
Fan control switch	25
Heat/Cool control switch	25
Pre-comfort recovery	26
Usage monitor	26
Filter change	27
Optional settings	27
Changing batteries	28
Reset.	29
Specifications	29
TROUBLESHOOTING GUIDE	30-31
Warranty	32

FEATURES

- Extra Large LCD display with backlight
- Real-time clock with selectable 12 or 24 hour display format
- 5+1+1 Day Programming with 4 programs per day
- Separate Heat / Cool programs with built-in protection for the air-conditioner compressor
- Display and set temperature in °C or °F
- Display of relative humidity in %
- Interface with heating or air-conditioning systems for automatic temperature control
- Interface with humidifier for automatic humidity control (THM303A only)
- Low battery notification by flashing icons and Beep sound

THM303A

- Open the thermostat by gently pulling the front of the thermostat away from the backplate.
- This thermostat requires two AA size batteries (included) to operate. Ensure the batteries are installed.
- Select °C or °F before clock setting and programming.

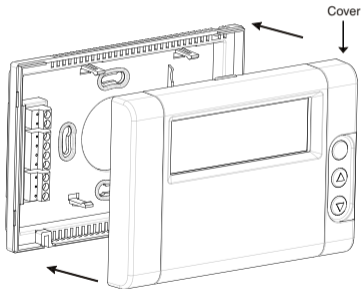

COMPATIBILITY CHART

Generally, equipment with low voltage control is compatible with this thermostat.

For details on compatibility of your particular equipment, please call our technical assistance line.

System Type	Compatible
Gas - Standing Pilot	Yes
Gas - Electronic Ignition	Yes
Gas - Fire Boiler	Some models
Gas - Millivolt System	Yes
Oil - Fire Boilers	Some models
Oil - Fire Furnace	Yes
Electric Furnace	Yes
Electric Air Conditioner	Yes
Baseboard Electric Heater (120/240V)	No
Heat Pump / Multi-Stage equipment	No

*** NOT COMPATIBLE WITH ANY 120/240 VOLT CIRCUIT**

A stylized, light gray illustration of a pair of pliers on the left and a screwdriver on the right, both rendered in a simple, line-art style. The pliers are open, and the screwdriver is oriented vertically with the handle at the top and the tip pointing downwards. The text "Installation Guide" is centered over the tools.

Installation Guide

INSTALLATION GUIDE

INTRODUCTION

This thermostat can replace common residential thermostats and it is designed for use with most electric, oil or gas heating and air-conditioning systems that use low voltage control. Please see compatibility chart for more details.

- Weekday / Saturday / Sunday programming with 4 programs per day.
- Display temperature with 0.1°.
- Built-in protection timing for the air-conditioner compressor.

If you have any questions concerning the installation or programming of the thermostat, please call 1-888-468-6876 for technical assistance.

INSTALLING THE BATTERY AND SELECTION OF °C/°F DISPLAY

Install the two AA size batteries (included) to the thermostat following the polarity as marked. The LCD display will show the room temperature flashing in Celsius. Press UP or DOWN to change the temperature display between °C and °F.

Press SET CLOCK, and the thermostat would go to clock setting / normal display.

Note: This is a one-time process. The temperature unit of the thermostat CANNOT be changed afterwards unless you reset the thermostat.

The following tools may be required for installation:

Cross screwdriver



Masking Tape

(To wrap the exposed wires temporarily and labeling the disconnected wires)



Wire Stripper/Cutter

(If necessary, to strip the wires)



Hand Power Drill with a 3/16 inch bit

(If necessary, to drill holes on the wall)



Level

(If necessary, to level the thermostat)



Two AA size batteries (included)

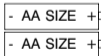

See below to select a suitable place for the new thermostat installation. And refer to **Replacing Old Thermostat** section to replace old thermostat.

CHOOSING LOCATION FOR THE NEW THERMOSTAT

Thermostat should be mounted:

- Approximately 5 ft (1.5m) from floor.
- Near or in a frequently used room, preferably on an inside partitioning wall.
- On a section of wall without pipes or duct-work

Thermostat should NOT be mounted:

- Near a window, on an outside wall, or next to a door leading outside.
- With exposure to direct light or heat from a lamp, sun, fireplace, or other temperature-radiating objects which may cause false readings.
- Near or in direct airflow from supply registers and return-air grills.
- Near concealed pipes and chimneys.
- In areas with poor air circulation, such as behind a door or in an alcove.

After choosing a location for the new thermostat, you may arrange to have a heating contractor install the control wiring for you.

REPLACING OLD THERMOSTAT

Note: Do not operate the cooling system when outside temperature is below 10°C (50°F) to avoid damaging the compressor.

- Test the system to make sure that your heating and cooling are working properly before installation. If either does not work, contact your local heating/air-conditioning dealer to fix the problem before installation.
- TURN OFF POWER to system at the furnace, or at the fuse/circuit breaker panel.
- Carefully unpack your new thermostat and mounting plate; save package of screws, instructions and receipt.
- Remove cover from old thermostat. If it does not snap off when pulled firmly from the bottom, check for a screw used to secure the cover.
- Loosen screws holding thermostat to the wall and lift away the thermostat.
- Disconnect wires from old thermostat or sub-base. As you disconnect each wire, use masking tape to label it with the old terminal designation. If there are only two wires, they don't need to be labeled.
- If there is an extra wire that is not connected to your old thermostat, then you won't need to connect it to the new thermostat.
- Take care not to let the wires fall back into the wall or let the ends of the wires touch one another.
- The wires are usually designated 'W', 'Y', 'G', 'RH', 'RC', 'O', 'B', 'H1', 'H2'.

MOUNTING THE THERMOSTAT BACK-COVER

- The back-cover should be mounted horizontally with the terminals on the left side.
- Thread the existing wiring through the big center hole from the back and set the back-cover horizontally on the wall.
- Select two appropriate mounting holes and mark the locations with a pencil. If necessary, use a level to make sure the thermostat is leveled.
- Remove the back-cover from the wall and drill two 3/16 inch holes in the marked screw positions. Insert the wall-anchors into the holes completely. If necessary, use a hammer to tap-in lightly.
- Mount the back-cover with the two screws to the wall. Make sure the metal terminals are on the left side.

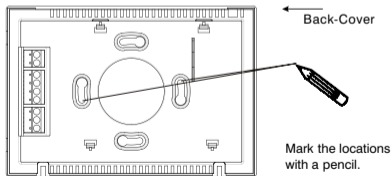
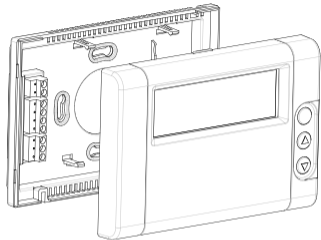

CONNECTING THE WIRES TO THE TERMINALS

Connect the previously labeled wires to the corresponding terminals, matching the designations. Use a screwdriver to securely fasten the wires onto the terminals. Make sure the wires do not short-circuit with other terminals.

- Depending on your heating/cooling equipment, you may need to connect 2 to 9 wires to the thermostat.
- If you have two 'R' wires, then connect each wire to its corresponding terminal and remove the JUMPER between the RC and RH terminals.
- If you are unsure of the connections, or for new installation, you may refer to the wiring diagrams on the next page.

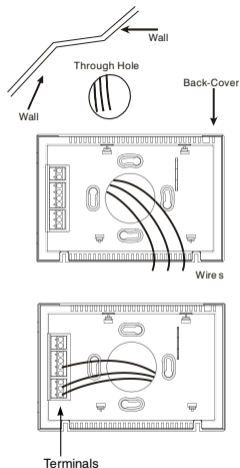

WIRING DIAGRAM

2-wire heating

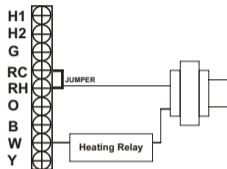

4-wire heating/cooling

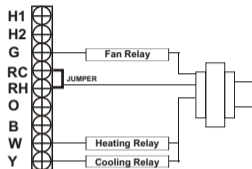

3-wire heating

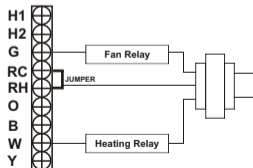

5-wire heating/cooling

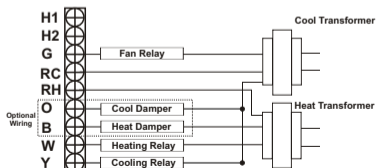

INSTALLING CONTROL WIRES FOR HUMIDIFIER CONTROL (THM303A ONLY)

- If control of the humidifier is desired, the 2 wires connecting the original humidistat needs to be connected to the 2 terminals marked 'H1' and 'H2'.
- The original humidistat should be removed or set to 'OFF' position.

Noted: The 2 humidifier control terminals 'H1' and 'H2' are electrically isolated from the Heat / Cool terminals.

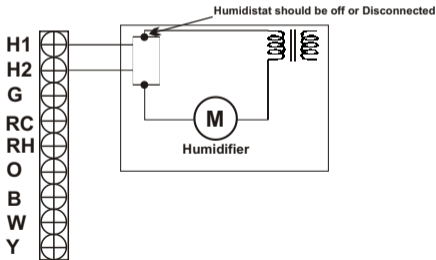

SETTING THE FAN OPERATION JUMPER

Depending on your home's heating system, you may need to change the jumper setting for the fan operation. The jumper is located at the lower right-hand side of the back of the thermostat.

- **HG** – Use this setting for gas or oil-fired furnaces. This setting allows the fan operation to be controlled by the heating system; not the thermostat. This is the correct setting for most systems.
- **HE** – Use this setting for electric powered furnaces. With this setting, the thermostat will turn on the fan immediately with the heating system.

The jumper is pre-installed in the 'HG' position as a factory default. So there is no need to change the jumper if this is the correct setting.

To change the jumper setting, pull out the small black rectangular block and align it to the new position and push it in fully.

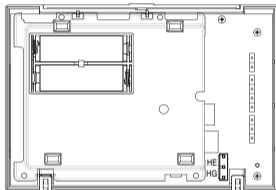

ATTACHING THE THERMOSTAT TO THE BACK-COVER

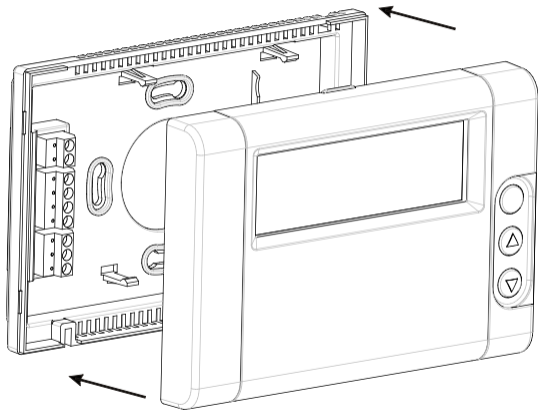

FUNCTION KEY DESCRIPTIONS

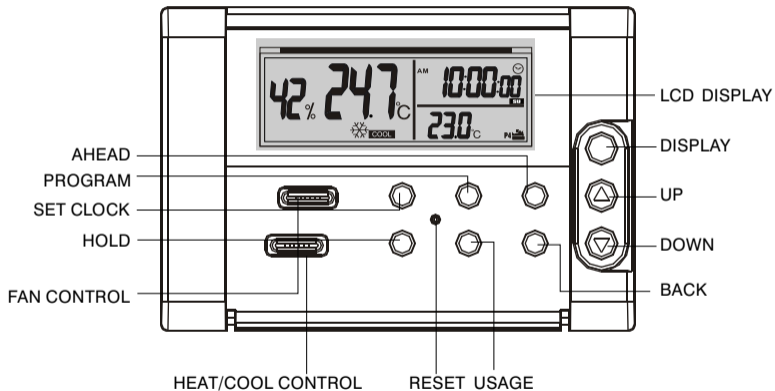

LCD DISPLAY

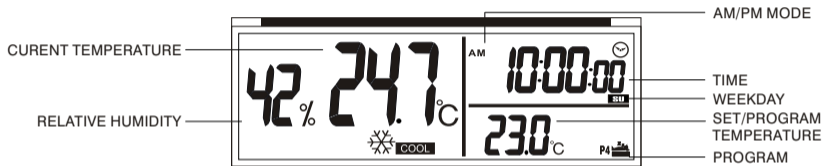

SET TIME AND DAY

- Press SET CLOCK to start time setting. The time and SET ⌚ symbol will flash.
- Use AHEAD or BACK to set the current time.
- Press SET CLOCK again. The day and SET ⌚ symbol will flash.
- Use AHEAD or BACK to set the current day.
- Press SET CLOCK again to exit.

PROGRAMMING

PROGRAMS

This thermostat is equipped with 5+1+1 day programming - separate programming for weekdays, Saturday and Sunday, with four settings per day. This thermostat is pre-programmed for your convenience or you can set your own programs as desired.

PROGRAM 1: MORNING: this is typically for the morning when you may prefer a warmer temperature.

PROGRAM 2: DAY: this is an energy-savings mode for the time you are away from home. The setting can be adjusted to minimize energy consumption.

PROGRAM 3: EVENING: this is for the time you return home and want the house at a comfortable temperature, typically warmer settings during winter and cooler settings during summer.

PROGRAM 4: NIGHT: this is a sleep mode. You may choose to set temperature for energy savings or comfort as desired.

NOTE: Heating and Cooling modes have separate programs.

Below is a Schedule of the Pre-programmed Time and Temperature Settings:

PERIOD	P	TIME	HEAT SETPOINT	COOL SETPOINT
MORNING	P1	6:00am	69.0°F (20.5°C)	77.0°F (25.0°C)
DAY	P2	8:00am	63.5°F (17.5°C)	84.0°F (29.0°C)
EVENING	P3	5:00pm	70.0°F (21.0°C)	77.0°F (25.0°C)
NIGHT	P4	10:00pm	62.5°F (17.0°C)	79.0°F (26.0°C)

HEATING PROGRAM

- 1- Slide the system switch to the HEAT position and press the PROG key once. The P1  and SET PROGRAM symbol will appear on the display. MO to FR symbol is shown indicating weekday program is being displayed. (Figure 1)
- 2- Use AHEAD or BACK to select the desired start time for weekday program 1.
- 3- Use UP or DOWN (on extreme right) to set the desired temperature.
- 4- Temperature can be set in increments of 0.5°.
- 5- Program time can be set in increments of 10 minutes.
- 6- After setting correct time and temperature for program 1, press PROG again to display weekday program 2. Repeat steps 2-5 for weekday programs (P2, P3 and P4) for Saturday and Sunday programming.

After setting of all 12 programs, press PROG again to will take you to humidity setting (see Humidifier Control) or press PROG twice to return to normal display.

Note: The PROG key can also be used anytime to review all the set programs. To terminate the programming sequence at anytime, press DISPLAY key.

Tip: Press and hold the AHEAD/BACK or UP/DOWN key to change the Numbers quickly.

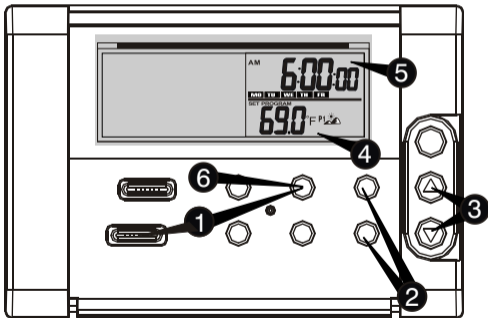

Figure 1

COOLING PROGRAM

Slide the system switch to the COOL position and repeat the programming as you would for the Heating programs.

Note: The Humidifier Control (THM303A) only functions in HEAT mode.

TEMPORARY OVERRIDE

To change the temperature temporarily, press UP or DOWN to set the desired temperature. The OVERRIDE symbol will appear. The thermostat will return to the regular program at the next scheduled program time.

Note: The thermostat has an automatic delay function to protect the heating and cooling systems from undesired on/off sequences. Sometimes there will be a delay of several minutes before the thermostat will activate the system.

HOLD FUNCTION

- This feature is to hold the thermostat at a constant temperature and disable all set programs until released.
- Press HOLD once and use UP or DOWN button to set the desired hold temperature. HOLD symbol will appear to indicate that the Hold function is active.
- To cancel Hold function, press HOLD again. The HOLD symbol will disappear and the thermostat will return to the programmed temperature.

CHECK PROGRAMS

- The current program is displayed on the lower right-hand section of the LCD screen.
- Press PROG anytime to scroll through and check all other programs.



current program

ROOM TEMPERATURE

- Current temperature is displayed on the mid-section of the LCD screen.



current temperature

RELATIVE HUMIDITY

- Relative humidity is displayed on the left-hand section of the LCD screen.



relative humidity

HUMIDIFIER CONTROL (THM303A ONLY)

- The humidifier control only works if the humidifier is connected to the thermostat.
Please refer to the **Installation Guide** for connection details.
- To set the humidity level, first you must scroll to the end of the 12 programs by pressing PROG. The SET HUMID symbol will appear and the humidity level setting will flash.



- Use UP or DOWN to set the humidity level in increments of 5%. Press PROG to exit.
- The humidifier will turn on if the room humidity is lower than the set humidity level. Humidity level can be set from 20% to 70%.

Note: The humidifier control only functions in HEAT mode.

FAN CONTROL SWITCH

- For automatic control of the fan, set the Fan ON/AUTO switch to the AUTO position. In cooling, the fan starts/stops with the cooling equipment. In heating, the fan is controlled by the heating equipment and usually starts a few minutes after the heating equipment turns on.
- To turn on the fan manually, set the Fan ON/AUTO switch to the ON position, the fan will run continuously to improve air ventilation. To return to automatic control, set the switch to the AUTO position.

HEAT/COOL CONTROL SWITCH

- If this switch is on the OFF position, both the heating and cooling systems are turned off, and all programs and settings will be disabled.
- Slide the switch to HEAT or COOL to control the heating or air-conditioning system.
-  will display when the switch is on the HEAT position, and will flash when heating is activated.
-  will display when the switch is on the COOL position, and will flash when cooling is activated.

PRE-COMFORT RECOVERY

This thermostat is equipped with a (Pre-Comfort Recovery) system that will activate the heating or cooling in advance of the actual set program time so that the room will be at the desired temperature at the start of the comfort program time.

It is normal for the system to be activated earlier (up to ½ hour for heating and one hour for cooling) than the actual set program time.

- The Pre-comfort Recovery can be disabled if desired. Please refer to **Optional Settings**.

USAGE MONITOR

- The thermostat tracks the system "ON" time, the time the heating/cooling equipment is running.
- Press USAGE once to view USAGE TODAY.
- Press USAGE again to view USAGE THIS WEEK.
- USAGE TODAY automatically resets itself daily at real-time 00:00.
- USAGE THIS WEEK automatically resets itself at the end of the week at real-time 00:00.
- A new week begins Monday morning.

FILTER CHANGE

- The FILTER CHANGE indicator  will display on the LCD screen when the system "ON" time (HEAT or COOL) has accumulated to approximately 500 hours. It is an indication that the filter should be changed at this time.

To reset the FILTER CHANGE counter press and hold USAGE for 3 seconds until the  appears momentarily. This brings the counter back to zero.

OPTIONAL SETTINGS

Below is the list of optional settings:

- 12/24 Hour display format.
- Heat Cycle Rate (select the cycle rate to match the heating equipment).
- Pre-comfort Recovery ON or OFF.
- Backlighting ON or OFF.

- To begin, press and hold SET CLOCK for 3 seconds.
- SET OPTION symbol will appear and either 12Hr or 24Hr will flash.
 - Select your preference of 12Hr or 24Hr by pressing UP or DOWN.
- Press SET CLOCK to move on to Cycle Rate.
 - Choose from Cr0 to Cr4 by pressing UP or DOWN. See Chart 1
 - Factory default is Cr3.

Cr	System	Cycles per Hour
Cr0	.	disabled
Cr1	Hydronic heat, condensing gas furnaces	2
Cr2	Commercial Unit	3
Cr3	Gas or oil forced air (default)	5
Cr4	Electric Heat	7

Chart 1

- Press SET CLOCK to move on to Pre-comfort Recovery ON/OFF and Backlight ON/OFF settings.
- Choose from OP0 to OP3 by pressing UP or DOWN. See Chart 2.
- Factory default is OP3
- The backlight only comes ON in the dark.
- If the Backlight is ON (enabled), any key press will turn the backlight ON for 6 seconds in the "dark".

OP	Options
OP0	Both Pre-comfort Recovery and Backlight are OFF
OP1	Only Pre-comfort Recovery - ON; Backlight - OFF
OP2	Pre-comfort Recovery - OFF; Only Backlight - ON
OP3	Both Pre-comfort Recovery and Backlight are ON

Chart 2

CHANGING BATTERIES

When 1) the battery symbol  on the LCD display flashes, or 2) Temperature & humidity in pane 1 are flashing, or 3) a Beep sound is heard from the unit, it indicates that the batteries are running low and have to be replaced immediately. However, it is recommended that the batteries be replaced every year even if the indicator is not flashing.

To replaced batteries:

- Set the thermostat system switch to the OFF position and have the new batteries on-hand.
- Open the thermostat by gently pulling the front of the thermostat away from the backplate.
- Remove the old batteries and install new ones quickly.
- Close the thermostat to its original position.

If new batteries are inserted within 20 seconds of removing the old ones, the existing time and programs will not be cleared. Otherwise, the display will show 9:00AM and the thermostat will have to be re-programmed.

RESET

If the thermostat shows an abnormal display or if you want to clear all existing programs, use a pointed object to press the 'R' key. Time and programs will need to be set again after a Reset.

SPECIFICATIONS

Number of Programs: 5+1+1 Day Programming with 4 programs per day

Temperature display range: 0°C - 55°C (34°F - 99.5°F)

Humidity display range: 20% to 95%

Temperature setting range: 5°C - 35°C (41°F - 95°F)

Humidity setting range: 20% to 70%

Storage temperature range: -20°C to 50°C (-4°F - 122°F)

Battery: 2 x AA size batteries

TROUBLESHOOTING GUIDE

PROBLEM

SOLUTION

Display will not come on.	<ol style="list-style-type: none">1) Check if the batteries are installed correctly.2) Check if the batteries are fresh and the correct size.3) Press the RESET button.
Battery symbol () is flashing. Buzzer beeping.	<ol style="list-style-type: none">1) Batteries are low. Replace with fresh batteries.
Air-conditioning will not come on (COOL symbol not flashing).	<ol style="list-style-type: none">1) System switch is on the HEAT or OFF position.2) Current temperature is lower than set temperature. Check current program.3) Air-conditioning has been turned off within 5 minutes, and automatic delay has been activated to protect the compressor.
Air-conditioning will not come on (COOL symbol flashing).	<ol style="list-style-type: none">1) Check if the air-conditioning main switch is turned on; it may have been turned off.

TROUBLESHOOTING GUIDE

PROBLEM

SOLUTION

Heating will not come on (HEAT symbol not flashing).	1) System switch is on the COOL or OFF position. 2) Current temperature is higher than set temperature. Check current program.
Heating will not come on (HEAT symbol flashing).	1) Check if the furnace switch and/or pilot flame is turned on; it may have been turned off. 2) Allow some time for the heater to heat up and the fan to activate. Most heaters will heat up the system for a short while before warm air can be ventilated by the fan. 3) HE/HG jumper inside the thermostat is not set correctly. Check installation guide.
The current temperature is different from the scheduled temperature.	- It is common for the setting and the displayed temperature to differ occasionally. The thermostat will be activated if this difference persists. There is a temporary override by the user. - The system is on HOLD . Press HOLD once to resume normal setting.

WARRANTY

This product has a three (3) year warranty against defects in workmanship and materials. This product is not guaranteed against wear or breakage due to misuse and/or abuse.

If the product is defective,

- return it, with a dated proof of purchase, to the retailer from which you purchased it.

Attention:

IT IS STRONGLY RECOMMENDED TO HAVE A CERTIFIED ELECTRICIAN ON SITE TO ENSURE THE SAFE INSTALLATION OF YOUR THERMOSTAT. The manufacturer assumes no responsibility for improper wiring, Or any resulting damages. Improper Installation automatically voids the warranty.

Note: shipping and handling for returns is not included under this warranty.

If you have any questions concerning this warranty, please call our customer service centre at **1-888-468-6876**, Monday to Friday, from 8:00am to 5:00pm MST.

NOT COMPATIBLE WITH ANY 120 / 240 VOLT CIRCUIT